

OS Series Miniature Slide Switches

Features/Benefits

- Variety of actuators & terminations
- PC and panel mounting
- Gold or silver plating available
- Shorting or non-shorting contacts
- RoHS compliant

Typical Applications

- Test & measurement equipment
- Computer peripherals & network products
- Consumer products



Specifications

CONTACT RATING: See individual parts.
 MECHANICAL & ELECTRICAL LIFE: 10,000 cycles.
 CONTACT RESISTANCE: 20 m Ω or less.
 INSULATION RESISTANCE: 100 m Ω min. at 500 VDC.
 DIELECTRIC STRENGTH: 500 VAC for 1 minute.
 OPERATING TEMPERATURE: -10°C to +70°C.
 PACKAGING: Bulk

* For RoHS compatible switches contact customer service.

Materials

BASE: Phenolic resin.
 ACTUATOR: POM, black.
 HOUSING PLATE: SPCC Sn plated.
 MOVABLE CONTACT: Copper alloy, silver plated or gold.
 STATIONARY CONTACTS: Brass, silver plated.
 TERMINALS: Brass, silver plated (Gold plate - Contact customer service).
 TERMINAL SEAL: None.

NOTE: Specifications and materials listed above are for switches with standard options. For information on specific and custom switches, consult Customer Service Center.



Slide

How To Order

Complete part numbers for OS Series Slide Switches are shown on pages J-37 through J-43.

PART NUMBER	SWITCH FUNCTION	
	POS. 1	POS. 2
OS102011MS2QN1 (Non-shorting)	ON	ON
OS102011MS2QS1 (Shorting)	ON	ON
CONN. TERMINALS	1-2	2-3
SCHEMATIC		
SPDT		
CONTACT RATING: 0.1A @ 12 VDC		

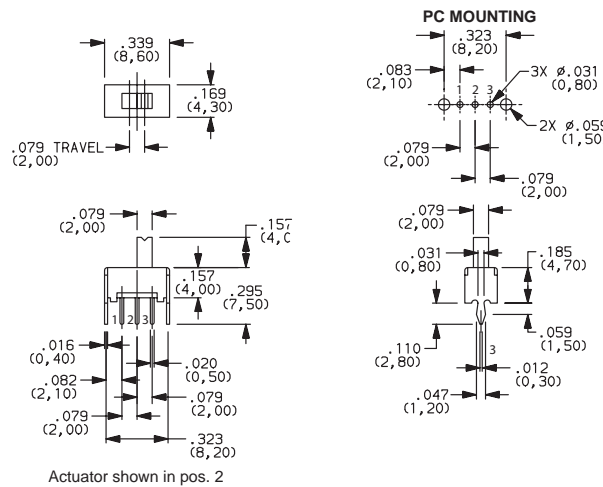

PART NUMBER	SWITCH FUNCTION		
	POS. 1	POS. 2	POS. 3
OS103011MS8QP1 (Non-specified)	ON	ON	ON
CONN. TERMINALS	1-2	2-3	2-4
SCHEMATIC			
SP3T			
CONTACT RATING: 0.1A @ 12 VDC			

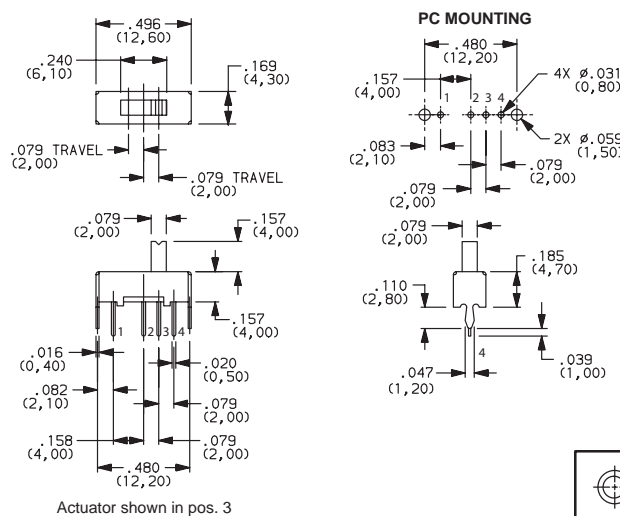

Dimensions are shown: Inch (mm)
 Specifications and dimensions subject to change



OS Series Miniature Slide Switches

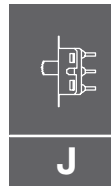

Slide



OS202011MS2QS1
DPDT

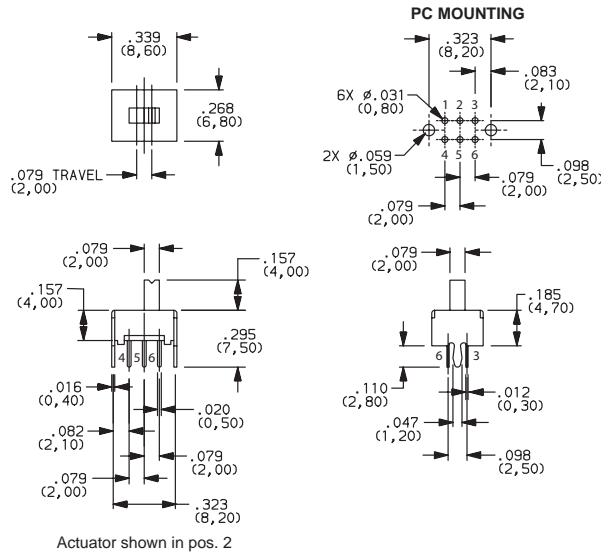

PART NUMBER	SWITCH FUNCTION	
	POS.1	POS. 2
OS202011MS2QS1 (Shorting)	ON	ON
OS202011MS2QN1 (Non-shorting)	ON	ON
CONN. TERMINALS	1-2,4-5	2-3,5-6
SCHEMATIC		
DPDT		
CONTACT RATING: 0.1A @ 12 VDC		



OS203011MS1QP1
DP3T

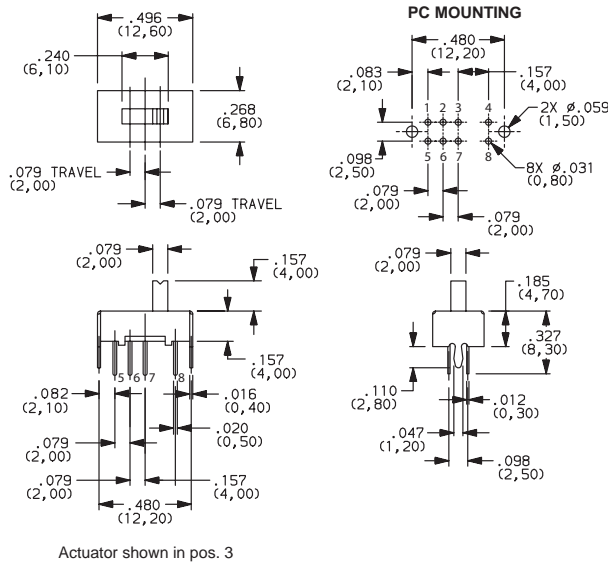

PART NUMBER	SWITCH FUNCTION		
	POS.1	POS. 2	POS. 3
OS203011MS1QP1 (Non-specified)	ON	ON	ON
CONN. TERMINALS	1-3,5-7	2-3,6-7	3-4,7-8
SCHEMATIC			
DP3T			
CONTACT RATING: 0.3A @ 30 VDC			



OS202013MT5QN1
DPDT

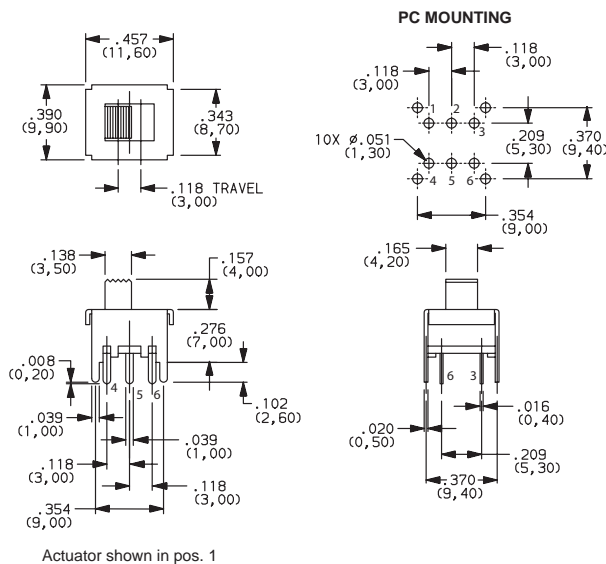

PART NUMBER	SWITCH FUNCTION	
	POS.1	POS. 2
OS202013MT5QN1 (Non-shorting)	ON	ON
CONN. TERMINALS	1-2,4-5	2-3,5-6
SCHEMATIC		
DPDT		
CONTACT RATING: 0.3A @ 30 VDC		

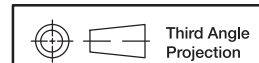

Dimensions are shown: IN (mm)
Specifications and dimensions subject to change

OS Series Miniature Slide Switches

PART NUMBER	SWITCH FUNCTION		
	POS. 1	POS. 2	POS. 3
OS203013MT7QN1 (Non-shorting)	ON	OFF	ON
CONN. TERMINALS	1-2,4-5		2-3,5-6
SCHEMATIC			
DP3T			
CONTACT RATING: 0.3A @ 30 VDC			

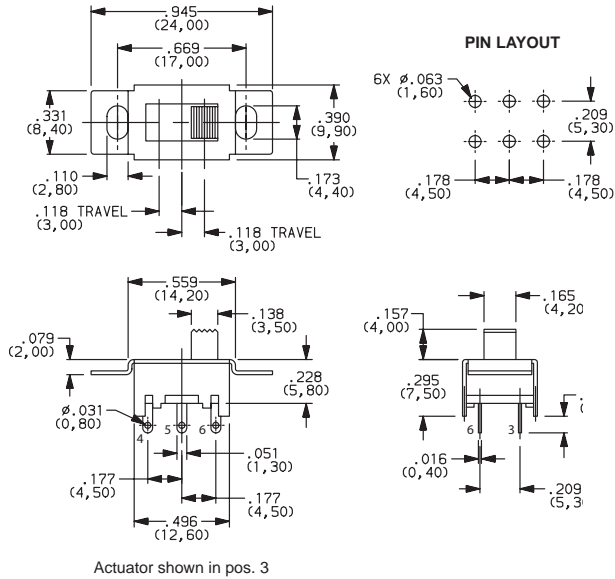

OS203013MT7QN1
DP3T



Slide

PART NUMBER	SWITCH FUNCTION	
	POS. 1	POS. 2
OS202013MT8QN1 (Non-shorting)	ON	ON
CONN. TERMINALS	1-2,4-5	2-3,5-6
SCHEMATIC		
DPDT		
CONTACT RATING: 0.3A @ 30 VDC		

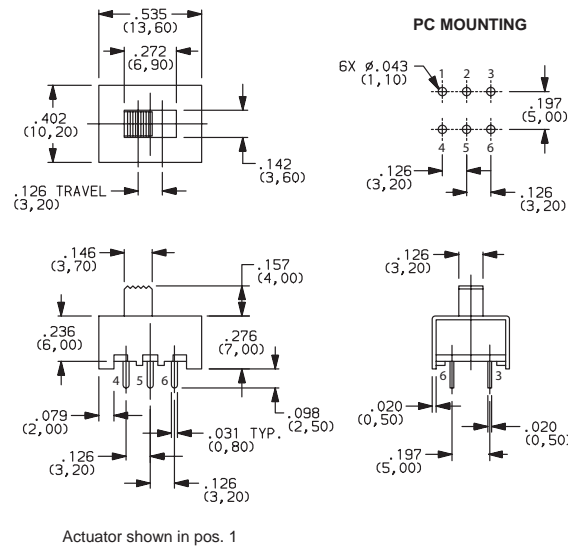

OS202013MT8QN1
DPDT

PART NUMBER	SWITCH FUNCTION		
	POS. 1	POS. 2	POS. 3
OS203013MT8QN1 (Non-shorting)	ON	ON	ON
CONN. TERMINALS	1-2,5-6	2-3,6-7	3-4,7-8
SCHEMATIC			
DP3T			
CONTACT RATING: 0.3A @ 30 VDC			

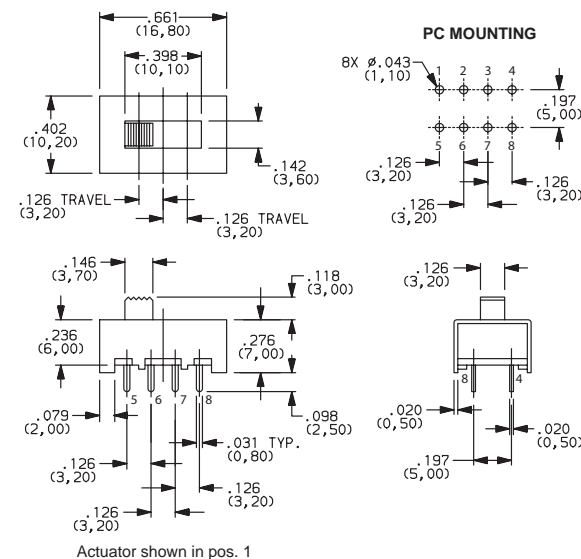

OS203013MT8QN1
DP3T

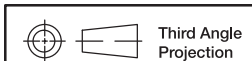

Dimensions are shown: Inch (mm)
Specifications and dimensions subject to change



OS Series Miniature Slide Switches



OS203013MT6QN1
DP3T

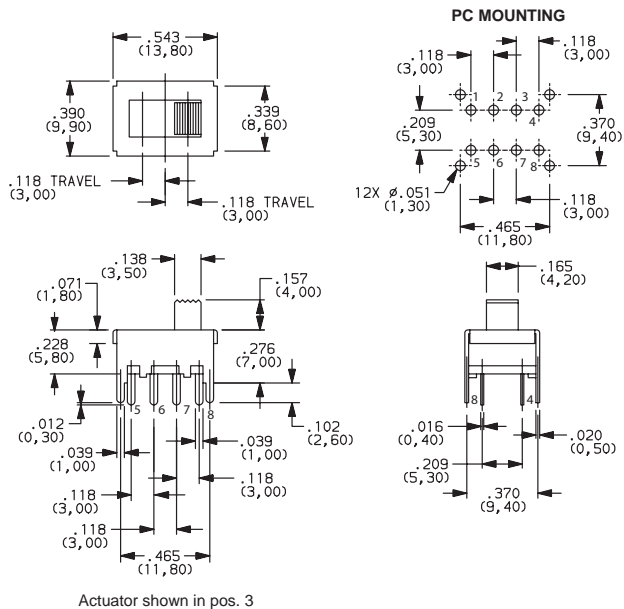

PART NUMBER	SWITCH FUNCTION		
	POS. 1	POS. 2	POS. 3
OS203013MT6QN1 (Non-shorting)	ON	ON	ON
CONN. TERMINALS	1-2,5-6	2-3,6-7	3-4,7-8
SCHEMATIC			
DP3T			
CONTACT RATING: 0.2A @ 30 VDC			



OS103012MU1QP1
SP3T

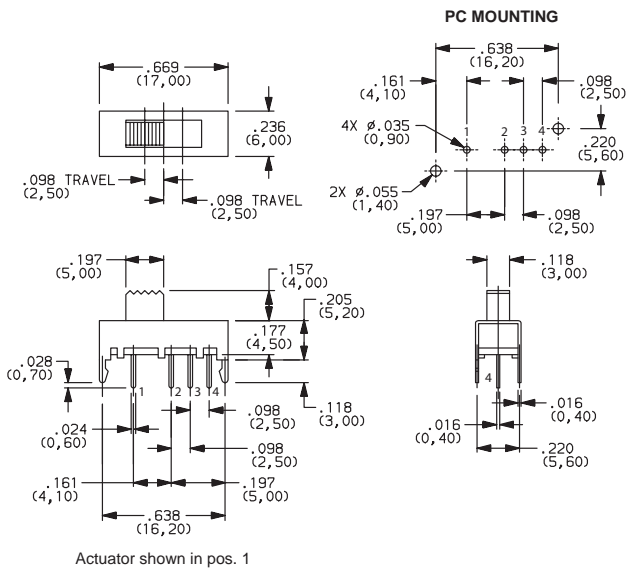

PART NUMBER	SWITCH FUNCTION		
	POS. 1	POS. 2	POS. 3
OS103012MU1QP1 (Non-shorting)	ON	ON	ON
CONN. TERMINALS	1-2	2-3	2-4
SCHEMATIC			
SP3T			
CONTACT RATING: 0.2A @ 30 VDC			



OS103012MU2QP1
SP3T

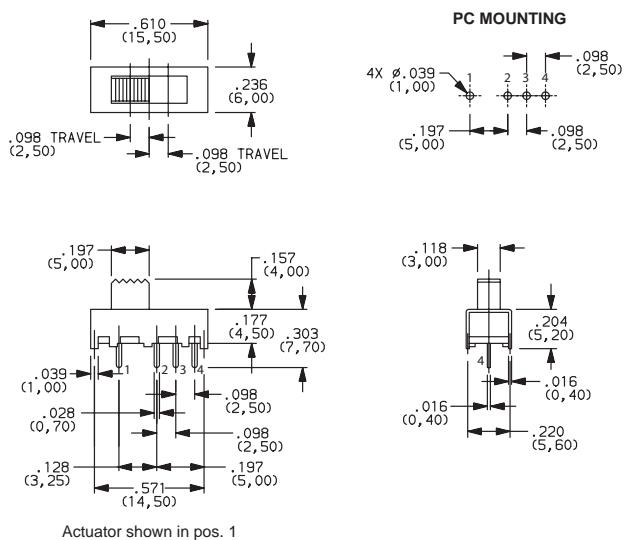

PART NUMBER	SWITCH FUNCTION		
	POS. 1	POS. 2	POS. 3
OS103012MU2QP1 (Non-shorting)	ON	ON	ON
CONN. TERMINALS	1-2	2-3	2-4
SCHEMATIC			
SP3T			
CONTACT RATING: 0.2A @ 30 VDC			



Dimensions are shown: IN (mm)
Specifications and dimensions subject to change



Slide

OS Series Miniature Slide Switches

PART NUMBER	SWITCH FUNCTION		
	POS. 1	POS. 2	POS. 3
OS203012MU5QP1 (Non-specified)	ON	ON	ON
CONN. TERMINALS	1-2,5-6	2-3,6-7	2-4,6-8
SCHEMATIC			
DP3T			
CONTACT RATING: 0.1A @ 30 VDC			

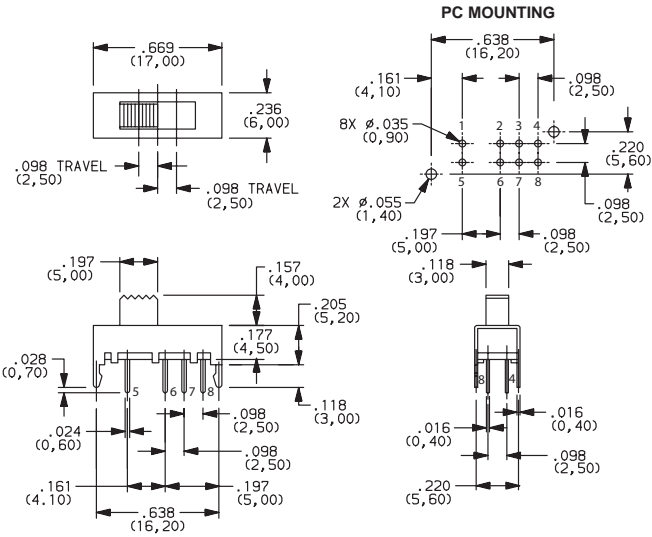

OS203012MU5QP1
DP3T



PART NUMBER	SWITCH FUNCTION	
	POS. 1	POS. 2
OS202011MV4QN1 (Non-shorting)	ON	ON
OS202011MV4QS1 (Shorting)	ON	ON
CONN. TERMINALS	1-2,4-5	2-3,5-6
SCHEMATIC		
DPDT		
CONTACT RATING: 0.1A @ 30 VDC		

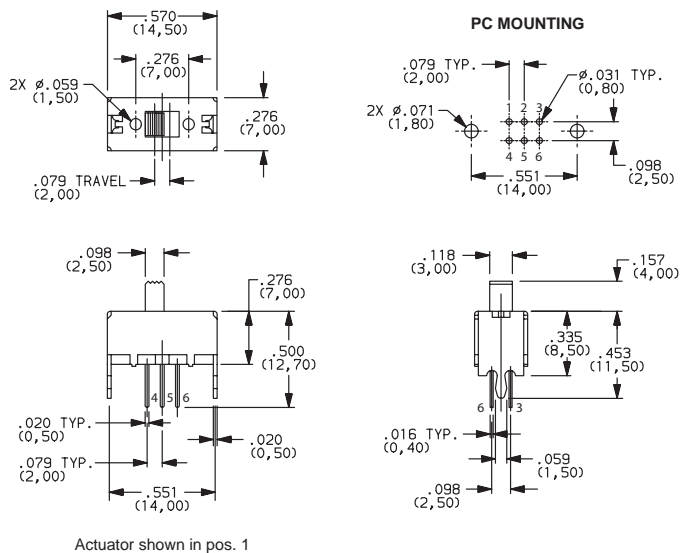

OS202011MV4QN1
DPDT

PART NUMBER	SWITCH FUNCTION		
	POS. 1	POS. 2	POS. 3
OS203011MV9QS1 (Shorting)	ON	ON	ON
OS203011MV9QN1 (Non-shorting)	ON	ON	ON
CONN. TERMINALS	1-2-5, 6-7-10	1-3-5, 6-8-10	1-4-5, 6-9-10
SCHEMATIC			
DP3T			
CONTACT RATING: 0.1A @ 30 VDC			

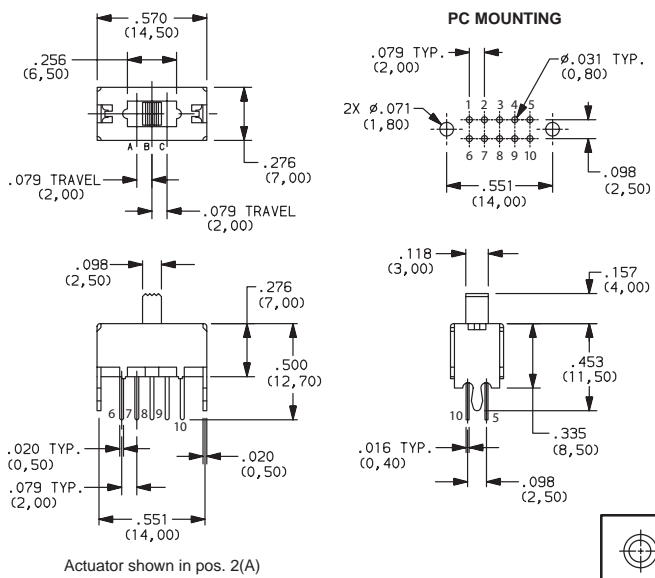

OS203011MV9QS1
DP3T



Third Angle Projection
Dimensions are shown: Inch (mm)
Specifications and dimensions subject to change



OS Series Miniature Slide Switches



OS102011MA1QN1
SPDT

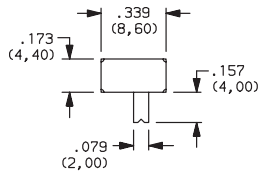

PC MOUNTING

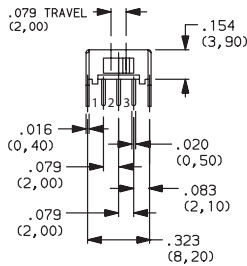
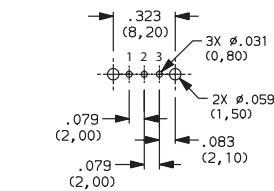

Actuator shown in pos. 2

PART NUMBER	SWITCH FUNCTION	
	POS.1	POS. 2
OS102011MA1QN1 (Non-shorting)	ON	ON
OS102011MA1QS1 (Shorting)	ON	ON
CONN. TERMINALS	1-2	2-3
SCHEMATIC		
SPDT		
CONTACT RATING: 0.1A @ 12 VDC		



Slide



OS103011MA7QP1
SP3T

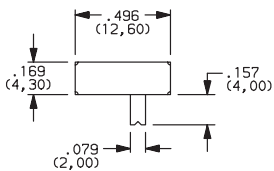

PC MOUNTING

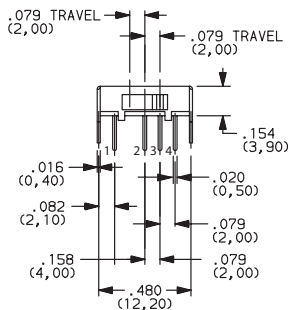
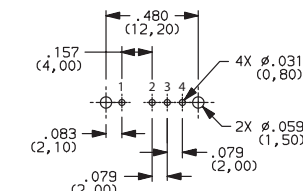

Actuator shown in pos. 3

PART NUMBER	SWITCH FUNCTION		
	POS.1	POS. 2	POS. 3
OS103011MA7QP1 (Non-specified)	ON	ON	ON
CONN. TERMINALS	1-2	2-3	2-4
SCHEMATIC			
SP3T			
CONTACT RATING: 0.1A @ 12 VDC			



OS203011MA2QP1
DP3T

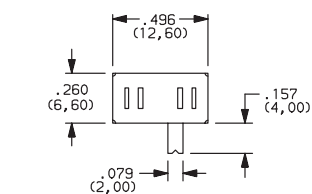

PC MOUNTING

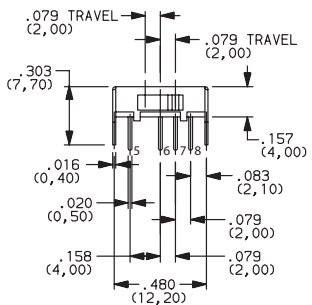
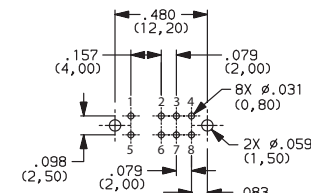

Actuator shown in pos. 3

PART NUMBER	SWITCH FUNCTION		
	POS.1	POS. 2	POS. 3
OS203011MA2QP1 (Non-specified)	ON	ON	ON
CONN. TERMINALS	1-2,5-6	2-3,6-7	2-4,6-8
SCHEMATIC			
DP3T			
CONTACT RATING: 0.1A @ 12 VDC			

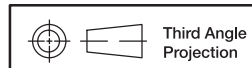

Dimensions are shown IN (mm)
Specifications and dimensions subject to change



OS Series Miniature Slide Switches

PART NUMBER	SWITCH FUNCTION	
	POS. 1	POS. 2
OS202011MA0QN1 (Non-shorting)	ON	ON
OS202011MA0QS1 (Shorting)	ON	ON
CONN. TERMINALS	1-2,4-5	2-3,5-6
SCHEMATIC		
DPDT		
CONTACT RATING: 0.1A @ 12 VDC		

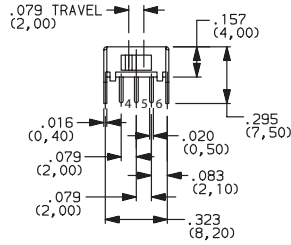
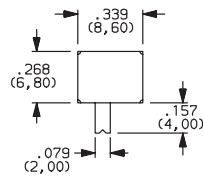

Actuator shown in pos. 1

PC MOUNTING

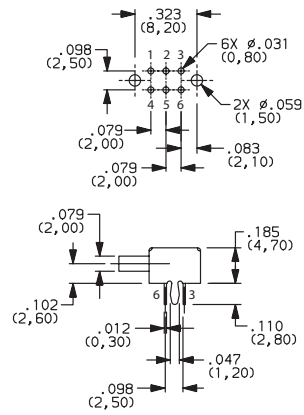

OS202011MA0QN1
DPDT

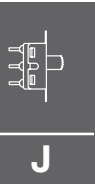

Slide